



WORM GEAR DC MOTORS

| Ø 43 - 123 mm
13 - 420W

Transmotec sell a broad range of geared DC motors in standard and customized configurations. Our motors are often available with gear heads, encoders and wire harnesses. Transmotec is the ideal supplier source especially to instrument and apparatus builders. We keep a high number of motors in stock for immediate delivery.

Customizations include:

- ✓ Customized harness
- ✓ Shaft configuration
- ✓ Winding configuration
- ✓ And more...

TABLE OF CONTENTS

Model	Voltage	Diameter	Power	Page
WLD4383	12V / 24V	43mm	13W / 15W	1
WRD6093	12V / 24V	60mm	23W / 23W	2
WRD63118	12V / 24V	63mm	40W / 45W	3
WLD70107	12V / 24V	70mm	65W / 65W	4
WRD8089	12V / 24V	80mm	126W / 126W	5
WHD80141	12V / 24V	80mm	90W / 90W	6
WHD80175	12V / 24V	80mm	230W / 230W	7
WLD89152	12V / 24V	89mm	201W / 201W	8
WHD123224	12V / 24V	123mm	421W / 421W	9
Magnetic encoder (48 counts per revolution, 2 channels)				10
Optical encoder (2000 counts per revolution, 2 channels)				10
Brake (electro mechanic)				10

WLD4383 / Ø 43mm / 12.5W / 14.8W

DRAWING (mm)

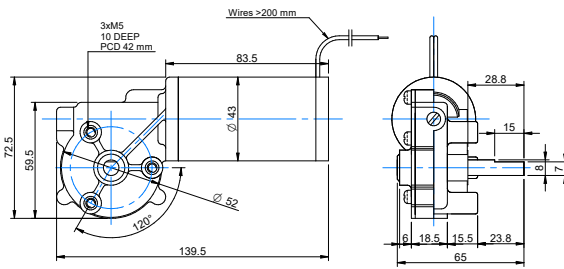

PHOTO



MODEL NO. DESIGNATION

WLD4383 - VOLTAGE - REDUCTION - ME / OE

Example: WLD4383-12-31

ME = Magnetic encoder
OE = Optical encoder

ADDITIONAL



Encoder

GEAR MOTOR DATA

Reduction	31:1	61:1	86:1
Nominal torque 12 V (Nm) *	0.75	1.34	1.71
Nominal speed 12 V (rpm) *	87	44	31
Nominal torque 24 V (Nm) *	0.75	1.34	1.71
Nominal speed 24 V (rpm) *	103	52	37
Length (mm)	139.5	139.5	139.5
Weight (g)	630	630	630

* Nominal speed and nominal torque have a tolerance of $\pm 15\%$

GEAR HEAD DATA

Reduction	31:1	61:1	86:1
Max. continuous torque (Nm)	1.5	1.7	1.9
Intermittently permissible torque (Nm)	1.7	1.9	2.0
Efficiency (%)	55	50	45
Weight (g)	270	270	270
Weight (kg)	0.6	0.6	0.6

GEAR MOTOR FEATURES AND STANDARD DATA

	STANDARD	CUSTOMIZATION OPTIONS
Type	Worm gear brush dc gear motor	
Gear angle	Left	Double or single right shaft
Motor type	Iron core, brush commutation	Winding parameters
Motor brush type	Carbon brushes	
Motor terminals	Cable wires 200 mm	Wiring harnesses, cables, connectors
EMC filter	No	Yes
Gear	Plastic	Metal
Bearing	Sleeve bearing	
Shaft	Hardened stainless steel	Dimensions
Encoder option	Magnetic or optical (option)	Through shaft dim. and screw holes
Environmental protection	IP55 (with encoder IP50)	
Operating temperature	-10...+60 °C	- 40...+60 °C
RoHS compliance	Yes	
CE label	No	Yes
UL approval	No	Yes

MOTOR DATA

Nominal voltage (V)	12	24
No load speed (rpm)	3600	4000
No load current (A)	1.0	0.5
Nominal speed (rpm)	2700	3200
Nominal torque (mNm)	44	44
Nominal current (A)	2.0	1.1
Stall torque mNm)	167	176
Starting current (A)	7	4
Output (W)	12.5	14.8
Length (mm)	83.5	83.5
Weight (g)	360	360

WRD6093 / Ø 60mm / 23W / 23W

DRAWING (mm)

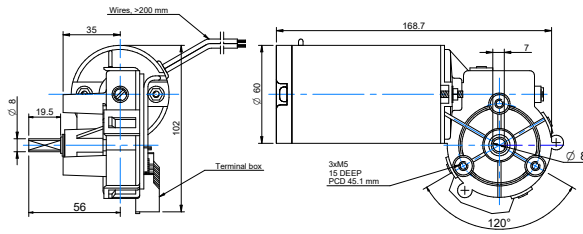

PHOTO



MODEL NO. DESIGNATION

WRD6093 - VOLTAGE - REDUCTION - ME / OE / B

Example: WRD6093-12-55

ME = Magnetic encoder
OE = Optical encoder
B = Brake

ADDITIONAL



Encoder



Brake

GEAR MOTOR DATA

Reduction	55:1
Nominal torque 12 V (Nm) *	2.9
Nominal speed 12 V (rpm) *	51
Nominal torque 24 V (Nm) *	2.9
Nominal speed 24 V (rpm) *	51
Length (mm)	167.7
Weight (kg)	1.4

* Nominal speed and nominal torque have a tolerance of $\pm 15\%$

GEAR HEAD DATA

Reduction	55:1
Max. continuous torque (Nm)	4.5
Intermittently permissible torque (Nm)	5.9
Efficiency (%)	67
Weight (kg)	0.4

GEAR MOTOR FEATURES AND STANDARD DATA

	STANDARD	CUSTOMIZATION OPTIONS
Type	Planetary gear brush dc gear motor	
Motor type	Iron core. brush commutation	Winding parameters
Motor brush type	Carbon brushes	
Motor terminals	Soldering terminals	Wiring harnesses. cables. connectors
EMC filter	No	Yes
Gear material	Metal	
Motor pinion material	Plastic	Metal
Bearing	Sleeve bearing	
Shaft	Hardened stainless steel	Dimensions
Encoder option	Magnetic/Optical (to order as option)	Through shaft dim. and screw holes
Environmental protection	IP55 (with encoder or brake IP50)	
Operating temperature	-10...+60 °C	- 40...+60 °C
RoHS compliance	Yes	
CE label	No	Yes
UL approval	No	Yes

MOTOR DATA

Nominal voltage (V)	12	24
No load speed (rpm)	3300	3300
No load current (A)	0.8	0.4
Nominal speed (rpm)	2800	2800
Nominal torque (mNm)	78	78
Nominal current (A)	2.8	1.40
Stall torque mNm)	372	372
Starting current (A)	15	7.5
Output (W)	23	23
Length (mm)	93	93
Weight (kg)	1.0	1.0

WRD63118 / Ø 63mm / 40.2W / 45.2W

DRAWING (mm)

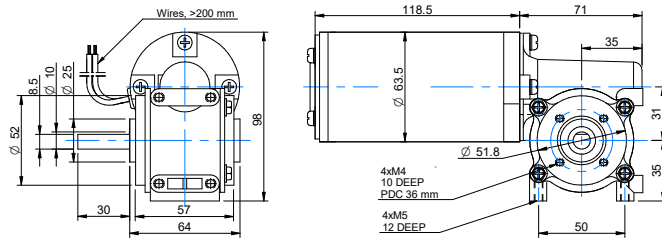

PHOTO



MODEL NO. DESIGNATION

WRD6093 - VOLTAGE - REDUCTION - ME / OE / B

Example: WRD6093-12-15

ME = Magnetic encoder
OE = Optical encoder
B = Brake

ADDITIONAL



Encoder



Brake

GEAR MOTOR DATA

	10:1	15:1	30:1
Reduction	10:1	15:1	30:1
Nominal torque 12 V (Nm) *	1.1	1.2	1.5
Nominal speed 12 V (rpm) *	245	163	81
Nominal torque 24 V (Nm) *	1.1	1.2	1.5
Nominal speed 24 V (rpm) *	275	183	92
Length (mm)	189.5	189.5	189.5
Weight (kg)	2.6	2.6	2.6

* Nominal speed and nominal torque have a tolerance of $\pm 15\%$

GEAR HEAD DATA

	10:1	15:1	30:1
Reduction	10:1	15:1	30:1
Max. continuous torque (Nm)	1.2	1.6	2.7
Intermittently permissible torque (Nm)	1.4	2.0	3.4
Efficiency (%)	70	50	32
Weight (kg)	1.3	1.3	1.3

GEAR MOTOR FEATURES AND STANDARD DATA

	STANDARD	CUSTOMIZATION OPTIONS
Type	Planetary gear brush dc gear motor	
Motor type	Iron core. brush commutation	Winding parameters
Motor brush type	Carbon brushes	
Motor terminals	Soldering terminals	Wiring harnesses. cables. connectors
EMC filter	No	Yes
Gear material	Metal	
Motor pinion material	Plastic	Metal
Bearing	Sleeve bearing	
Shaft	Hardened stainless steel	Dimensions
Encoder option	Magetic/Optical (to order as option)	Through shaft dim. and screw holes
Environmental protection	IP55 (with encoder or brake IP50)	
Operating temperature	-10...+60 °C	- 40...+60 °C
RoHS compliance	Yes	
CE label	No	Yes
UL approval	No	Yes

MOTOR DATA

	12	24
Nominal voltage (V)	12	24
No load speed (rpm)	3000	3300
No load current (A)	1.20	0.65
Nominal speed (rpm)	2450	2750
Nominal torque (mNm)	157	156
Nominal current (A)	4.3	2.4
Stall torque Nm)	1.1	1.1
Starting current (A)	26	13.5
Output (W)	40.2	45.2
Length (mm)	118	118
Weight (kg)	1.3	1.3

WLD70107 / Ø 70mm / 64.7W / 64.7W

DRAWING (mm)

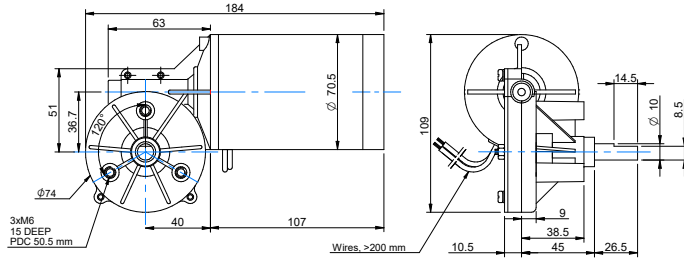

PHOTO



MODEL NO. DESIGNATION

WRD6093 - VOLTAGE - REDUCTION - B
B = Brake

Example: WRD6093-12-65

ADDITIONAL



Brake

GEAR MOTOR DATA

Reduction	65:1
Nominal torque 12 V (Nm) *	7.4
Nominal speed 12 V (rpm) *	53
Nominal torque 24 V (Nm) *	7.4
Nominal speed 24 V (rpm) *	53
Length (mm)	184
Weight (kg)	2.3

* Nominal speed and nominal torque have a tolerance of $\pm 15\%$

GEAR HEAD DATA

Reduction	65:1
Max. continuous torque (Nm)	7.8
Intermittently permissible torque (Nm)	8.3
Efficiency (%)	64
Weight (kg)	0.8

GEAR MOTOR FEATURES AND STANDARD DATA

	STANDARD	CUSTOMIZATION OPTIONS
Type	Worm gear brush dc gear motor	
Gear angle	Left	
Motor type	Iron core, brush commutation	Winding parameters
Motor brush type	Carbon brushes	
Motor terminals	Cable wires 200 mm	Wiring harnesses, cables, connectors
EMC filter	No	Yes
Gear	Plastic	Metal
Bearing	Sleeve bearing	
Shaft	Hardened stainless steel	Dimensions
Brake option	Electric brake (to order as option)	
Environmental protection	IP55 (with encoder or brake IP50)	
Operating temperature	-10...+60 °C	- 40...+60 °C
RoHS compliance	Yes	
CE label	No	Yes
UL approval	No	Yes

MOTOR DATA

Nominal voltage (V)	12	24
No load speed (rpm)	3900	3900
No load current (A)	1.10	0.55
Nominal speed (rpm)	3500	3500
Nominal torque (mNm)	176	176
Nominal current (A)	7	3.5
Stall torque Nm)	1.8	1.8
Starting current (A)	42	21
Output (W)	64.7	64.7
Length (mm)	107	107
Weight (kg)	1.5	1.5

WHD80141 / Ø 80mm / 90W / 90W

DRAWING (mm)

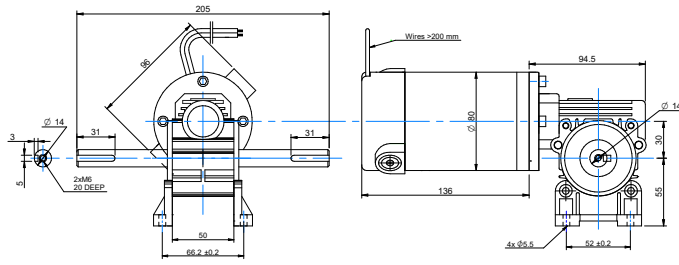

PHOTO



MODEL NO. DESIGNATION

WHD80141 - VOLTAGE - REDUCTION - ME / OE / B

Example: WHD80141-12-10

ME = Magnetic encoder
OE = Optical encoder
B = Brake

ADDITIONAL



Encoder



Brake

GEAR MOTOR DATA

	10:1	15:1	20:1	25:1	30:1	40:1	50:1
Reduction	10:1	15:1	20:1	25:1	30:1	40:1	50:1
Nominal torque 12 V (Nm) *	2.5	3.3	4.2	5.2	5.7	6.0	7.3
Nominal speed 12 V (rpm) *	245	163	122	98	81	61	49
Nominal torque 24 V (Nm) *	2.5	3.3	4.2	5.2	5.7	6.0	7.3
Nominal speed 24 V (rpm) *	245	163	122	98	81	61	49
Length (mm)	230	230	230	230	230	230	230
Weight (kg)	5.6	5.6	5.6	5.6	5.6	5.6	5.6

* Nominal speed and nominal torque have a tolerance of $\pm 15\%$

GEAR HEAD DATA

	10:1	15:1	20:1	25:1	30:1	40:1	50:1
Reduction	10:1	15:1	20:1	25:1	30:1	40:1	50:1
Max. continuous torque (Nm)	12	14	16	18	20	20	20
Intermittently permissible torque (Nm)	15	17	19	22	24	24	24
Efficiency (%)	72	65	62	60	46	44	42
Weight (kg)	1.6	1.6	1.6	1.6	1.6	1.6	1.6

GEAR MOTOR FEATURES AND STANDARD DATA

	STANDARD	CUSTOMIZATION OPTIONS
Type	Worm gear brush dc gear motor	
Gear angle	Left	
Motor type	Iron core, brush commutation	Winding parameters
Motor brush type	Carbon brushes	
Motor terminals	Cable wires 200 mm	Wiring harnesses, cables, connectors
EMC filter	No	Yes
Gear	Plastic	Metal
Bearing	Ball bearing	
Shaft	Hardened stainless steel	Dimensions
Environmental protection	IP55 (with encoder or brake IP50)	
Operating temperature	-10...+60 °C	-40...+60 °C
RoHS compliance	Yes	
CE label	No	Yes
UL approval	No	Yes
UL approval	No	Yes

MOTOR DATA

Nominal voltage (V)	12	24
No load speed (rpm)	2800	2800
No load current (A)	2.5	1.2
Nominal speed (rpm)	2450	2450
Nominal torque (Nm)	3.5	3.5
Nominal current (A)	9.6	4.8
Stall torque (Nm)	2.2	2.2
Starting current (A)	74	37
Output (W)	90	90
Length (mm)	144	144
Weight (kg)	4	4

WHD80175 / Ø 80mm / 230W / 230W

DRAWING (mm)

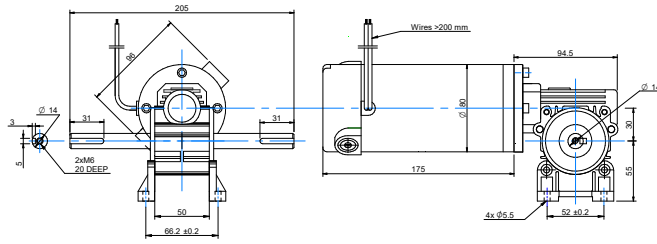

PHOTO



MODEL NO. DESIGNATION

WHD80175 - VOLTAGE - REDUCTION - ME / OE / B

Example: WHD80175-12-10

ME = Magnetic encoder
OE = Optical encoder
B = Brake

ADDITIONAL



Encoder



Brake

GEAR MOTOR DATA

	10:1	15:1	20:1	25:1	30:1	40:1	50:1
Reduction	10:1	15:1	20:1	25:1	30:1	40:1	50:1
Nominal torque 12 V (Nm) *	4.9	6.7	8.5	10.4	9.5	12.0	14.5
Nominal speed 12 V (rpm) *	320	213	160	128	106	80	64
Nominal torque 24 V (Nm) *	4.9	6.7	8.5	10.4	9.5	12.0	14.5
Nominal speed 24 V (rpm) *	320	213	160	128	106	80	64
Length (mm)	269	269	269	269	269	269	269
Weight (kg)	7.1	7.1	7.1	7.1	7.1	7.1	7.1

* Nominal speed and nominal torque have a tolerance of $\pm 15\%$

GEAR HEAD DATA

	10:1	15:1	20:1	25:1	30:1	40:1	50:1
Reduction	10:1	15:1	20:1	25:1	30:1	40:1	50:1
Max. continuous torque (Nm)	12	14	16	18	20	20	20
Intermittently permissible torque (Nm)	15	17	19	22	24	24	24
Efficiency (%)	72	65	62	60	46	44	42
Weight (kg)	1.6	1.6	1.6	1.6	1.6	1.6	1.6

GEAR MOTOR FEATURES AND STANDARD DATA

	STANDARD	CUSTOMIZATION OPTIONS
Type	Worm gear brush dc gear motor	
Gear angle	Left	
Motor type	Iron core, brush commutation	Winding parameters
Motor brush type	Carbon brushes	
Motor terminals	Cable wires 200 mm	Wiring harnesses, cables, connectors
EMC filter	No	Yes
Gear	Plastic	Metal
Bearing	Ball bearing	
Shaft	Hardened stainless steel	Dimensions
Environmental protection	IP55 (with encoder or brake IP50)	
Operating temperature	-10...+60 °C	-40...+60 °C
RoHS compliance	Yes	
CE label	No	Yes
UL approval	No	Yes
UL approval	No	Yes

MOTOR DATA

Nominal voltage (V)	12	24
No load speed (rpm)	3600	3600
No load current (A)	4.2	2.1
Nominal speed (rpm)	3200	3200
Nominal torque (mNm)	686	686
Nominal current (A)	24	12
Stall torque (Nm)	3.8	3.8
Starting current (A)	117	58
Output (W)	230	230
Length (mm)	181	181
Weight (kg)	5.5	5.5

WLD89152 / Ø 89mm / 201W / 201W

DRAWING (mm)

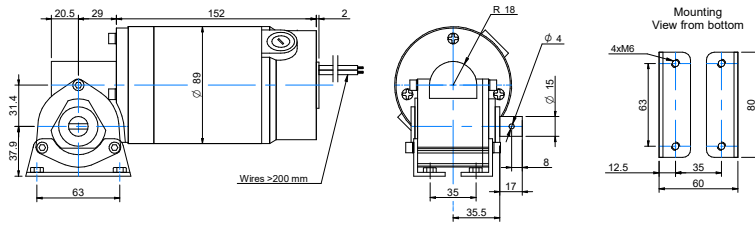

PHOTO



MODEL NO. DESIGNATION

WLD89152 - VOLTAGE - REDUCTION

Example: WLD89152-12-6

ADDITIONAL

GEAR MOTOR DATA

	6:1	10:1	15:1	30:1
Reduction	6:1	10:1	15:1	30:1
Nominal torque 12 V (Nm) *	3.4	4.9	6.2	8.5
Nominal speed 12 V (rpm) *	408	245	163	81
Nominal torque 24 V (Nm) *	3.4	4.9	6.2	8.5
Nominal speed 24 V (rpm) *	408	245	163	81
Length (mm)	221	221	221	221
Weight (kg)	4.4	4.4	4.4	4.4

* Nominal speed and nominal torque have a tolerance of ± 15%

GEAR HEAD DATA

	6:1	10:1	15:1	30:1
Reduction	6:1	10:1	15:1	30:1
Max. continuous torque (Nm)	7	8	12	20
Intermittently permissible torque (Nm)	8	10	14	24
Efficiency (%)	72	62	53	36
Weight (kg)	1	1	1	1

GEAR MOTOR FEATURES AND STANDARD DATA

	STANDARD	CUSTOMIZATION OPTIONS
Type	Worm gear brush dc gear motor	
Gear shaft	Left	Right
Motor type	Iron core, brush commutation	Winding parameters
Motor brush type	Carbon brushes	
Motor terminals	Cable wires 200 mm	Wiring harnesses, cables, connectors
EMC filter	No	Yes
Gear	Metal	
Bearing	Ball bearing	
Shaft	Hardened stainless steel	Dimensions
Environmental protection	IP55 (with encoder or brake IP50)	
Operating temperature	-10...+60 °C	- 40...+60 °C
RoHS compliance	Yes	
CE label	No	Yes
UL approval	No	Yes
UL approval	No	Yes

MOTOR DATA

	12	24
Nominal voltage (V)	12	24
No load speed (rpm)	2800	2800
No load current (A)	3.8	1.9
Nominal speed (rpm)	2450	2450
Nominal torque (mNm)	784	784
Nominal current (A)	21	10
Stall torque (Nm)	4.7	4.7
Starting current (A)	160	80
Output (W)	201	201
Length (mm)	152	152
Weight (kg)	3.4	3.4

WHD123224 / Ø 123mm / 421W / 421W

DRAWING (mm)

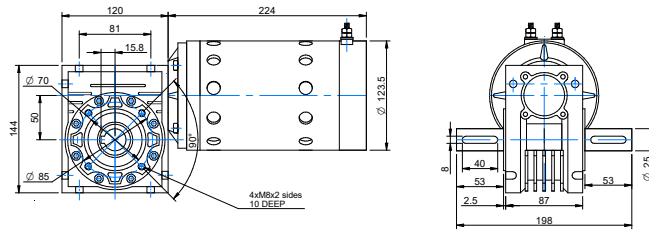

PHOTO



MODEL NO. DESIGNATION

WHD123224 - VOLTAGE - REDUCTION

Example: WHD123224-12-10

ADDITIONAL

GEAR MOTOR DATA					
Reduction	10:1	15:1	20:1	30:1	40:1
Nominal torque 12 V (Nm) *	13	16	21	32	41
Nominal speed 12 V (rpm) *	202	135	101	67	50
Nominal torque 24 V (Nm) *	13	16	21	32	41
Nominal speed 24 V (rpm) *	202	135	101	67	50
Length (mm)	344	344	344	344	344
Weight (kg)	14	14	14	14	14

* Nominal speed and nominal torque have a tolerance of $\pm 15\%$

GEAR HEAD DATA					
Reduction	10:1	15:1	20:1	30:1	40:1
Max. continuous torque (Nm)	24	34	39	49	58
Intermittently permissible torque (Nm)	34	44	49	58	68
Efficiency (%)	66	55	53	52	51
Weight (kg)	3.5	3.5	3.5	3.5	3.5

GEAR MOTOR FEATURES AND STANDARD DATA		
	STANDARD	CUSTOMIZATION OPTIONS
Type	Worm gear brush dc gear motor	
Gear angle	Hollow shaft	
Motor type	Iron core, brush commutation	Winding parameters
Motor brush type	Carbon brushes	
Motor terminals	Screw bolt terminal	Wiring harnesses, cables, connectors
EMC filter	No	Yes
Gear	Metal	
Bearing	Ball bearing	
Shaft	Hardened stainless steel	Dimensions
Environmental protection	IP55 (with encoder or brake IP50)	
Operating temperature	-10...+60 °C	-40...+60 °C
RoHS compliance	Yes	
CE label	No	Yes
UL approval	No	Yes
UL approval	No	Yes

MOTOR DATA		
Nominal voltage (V)	12	24
No load speed (rpm)	2400	2400
No load current (A)	5.5	2.5
Nominal speed (rpm)	2020	2020
Nominal torque (mNm)	1990	1990
Nominal current (A)	43	22
Stall torque (Nm)	8.2	8.2
Starting current (A)	262	131
Output (W)	421	421
Length (mm)	224	224
Weight (kg)	10.5	10.5

Magnetic encoder / 48 counts per revolution / 2 channels
Optical encoder / 2000 counts per revolution / 2 channels

DRAWING
(mm)

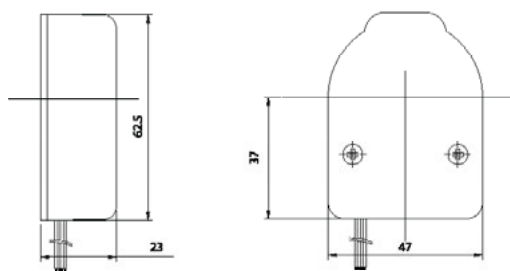

PHOTO



ENCODER DATA

	MAGNETIC		OPTICAL	
Pulses per revolution PPR two channels	24		1000	
Counts per revolution CPR two channels	48		2000	
Phase shift	90°		90°	
VCC	+5 VDC	Orange lead	+5 VDC	Pin 1
GND	0 VDC	Green lead	0 VDC	Pin 5, Pin 8
Signal A		Blue lead		A- Pin 6
Signal B		Yellow lead		B- Pin 7
Current			< 80 mA	
Index			Z+ Pin 4	
Output wave			Line driver	
Frequency response			25 KHz max.	
Connection	Flying wire		DB9 female	
Weight			< 100g	
Wire length	400mm		110mm	

Brake / Electro mechanic

DRAWING
(mm)

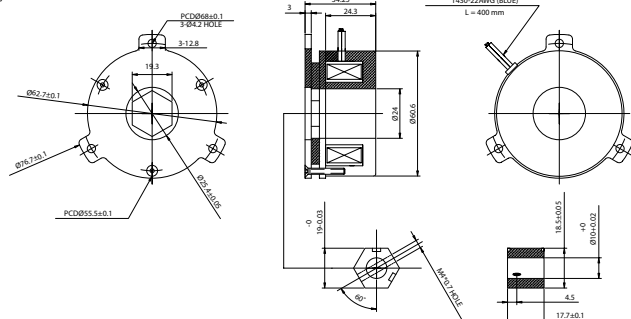

PHOTO



BRAKE DATA

Voltage	24VDC
Power	16W
Resistance	35Ω ±5%
Insulation class	F
Dynamic friction	3.4 Nm
Static friction	3.9 Nm
Insulation resistance	500 VDC / 50 MΩ
Insulation capacity	1500 VAC / 1mA / 1s
Release time	40 ms
Activation time	140 ms
Operating voltage	12V
Release voltage	5V
Clearance	0.12~0.15 mm
Weight	0.7 kg
Wire length	400 mm